

SMALL LOUNGE

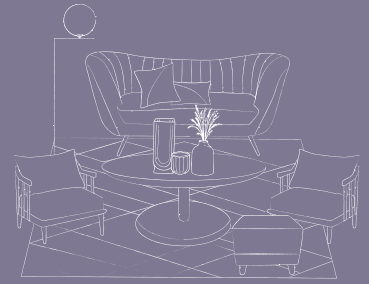

08

PILLOWS

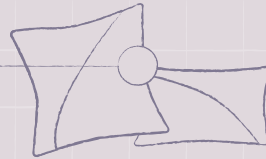

07

FLOOR LAMP

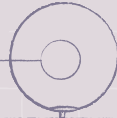

06

LOVESEAT

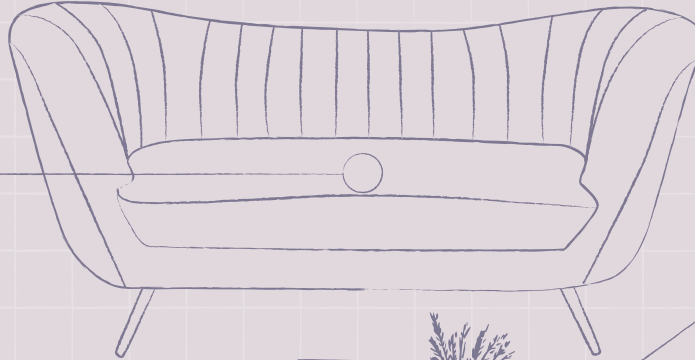

05

ACCENT DECOR

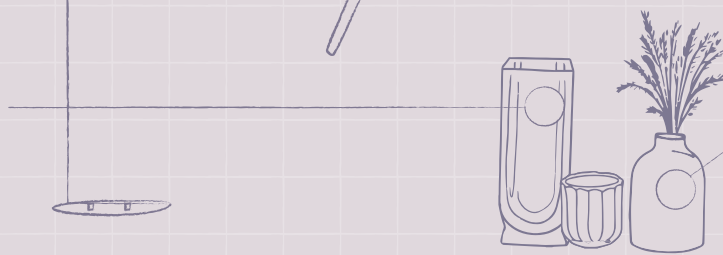

Remember the Rule of 3's for decor clusters. Use varying heights for a more dynamic look

04

COFFEE TABLE

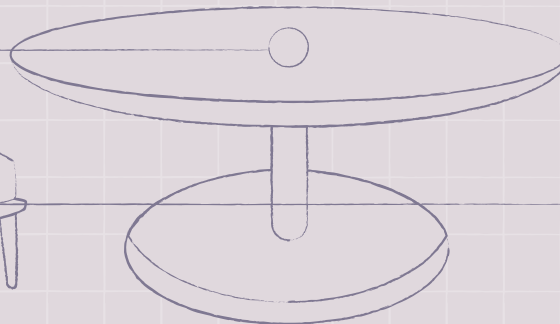

03

SIDE CHAIRS

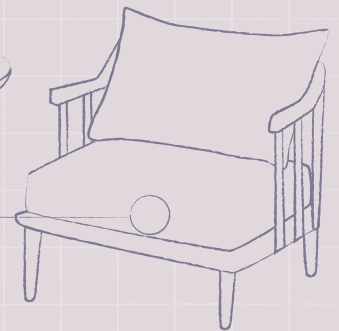
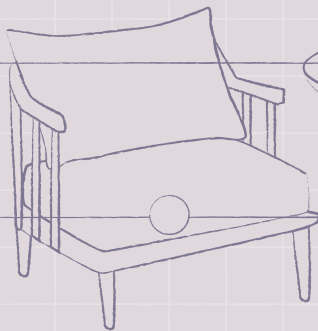

02

OTTOMAN/POUF

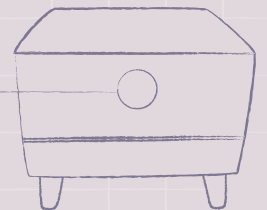

01

RUG

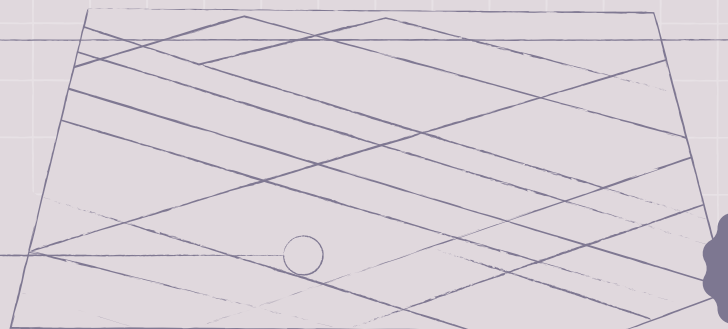

Make sure at least the front feet of the sofa are placed on the rug

